



**INSULATED
ROOF AND WALL
SANDWICH PANELS**



teknopanel®

INSULATED SANDWICH ROOF PANELS



PUR/PIR Insulated 3 Ribs Roof Panel RP-3S / RI-3S

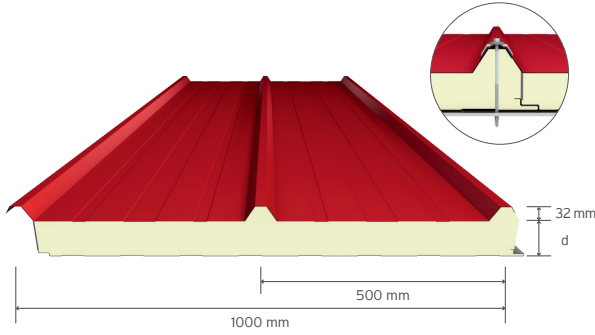

Core Material	PUR PIR
Fire Performance	B-s2; d0 B-s1; d0
Core Thickness = d (mm)	40 50 60 70 75 80 100 120 150 180 200
Distributed Load* (kg/m²)	169 211 246 277 291 305 355 399 458 509 540
Outer Sheet Thickness (mm)	0,45 - 0,50 - 0,60 - 0,70 - 0,80
Inner Sheet Thickness (mm)	0,35 - 0,40 - 0,45 - 0,50 - 0,60 - 0,70 - 0,80
Place of Production	Mersin, Sakarya, İzmir
Certificates	
Usage Areas	

* Uniformly distributed load values calculated according to 0,50 mm outer sheet, 0,40 mm inner sheet and 1,50 m multi span.
 ** Certificate is valid for PIR insulated panels.

PUR/PIR Insulated 5 Ribs Roof Panel RP-5S / RI-5S

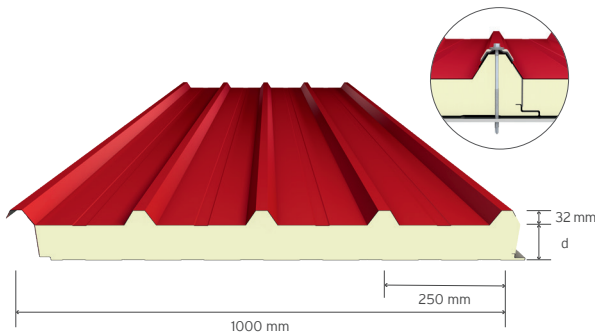

Core Material	PUR PIR
Fire Performance	B-s2; d0 B-s1; d0
Core Thickness = d (mm)	40 50 60 70 75 80 100 120 150 180 200
Distributed Load* (kg/m²)	241 300 349 391 411 430 498 558 640 712 757
Outer Sheet Thickness (mm)	0,45 - 0,50 - 0,60 - 0,70 - 0,80
Inner Sheet Thickness (mm)	0,35 - 0,40 - 0,45 - 0,50 - 0,60 - 0,70 - 0,80
Place of Production	Mersin, Sakarya, İzmir
Certificates	
Usage Areas	

* Uniformly distributed load values calculated according to 0,50 mm outer sheet, 0,40 mm inner sheet and 1,50 m multi span.
 ** Certificate is valid for PIR insulated panels.

PUR/PIR Insulated 3 Ribs Secret Fix Roof Panel RP-3H / RI-3H

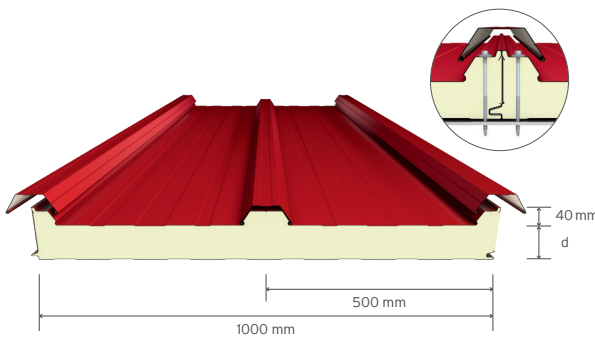

Core Material	PUR PIR
Fire Performance	B-s2; d0 B-s1; d0
Core Thickness = d (mm)	40 50 60 70 75 80 100 120 150 180 200
Distributed Load* (kg/m²)	201 266 318 362 382 400 468 527 606 677 720
Outer Sheet Thickness (mm)	0,45 - 0,50 - 0,60 - 0,70
Inner Sheet Thickness (mm)	0,35 - 0,40 - 0,45 - 0,50 - 0,60 - 0,70
Place of Production	Sakarya
Certificates	
Usage Areas	

* Uniformly distributed load values calculated according to 0,50 mm outer sheet, 0,40 mm inner sheet and 1,50 m multi span.
 ** Certificate is valid for PIR insulated panels.

PUR/PIR Insulated 5 Ribs Secret Fix Roof Panel RP-5H / RI-5H

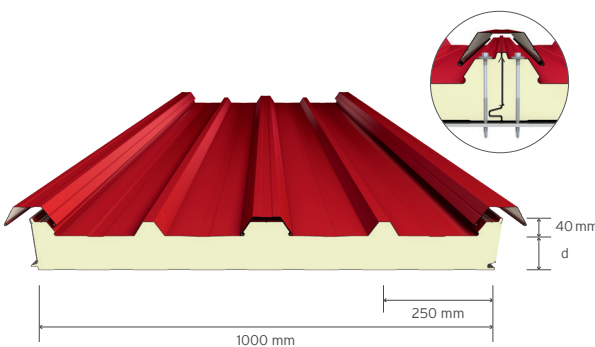

Core Material	PUR PIR
Fire Performance	B-s2; d0 B-s1; d0
Core Thickness = d (mm)	40 50 60 70 75 80 100 120 150 180 200
Distributed Load* (kg/m²)	263 342 405 458 483 505 587 657 736 743 747
Outer Sheet Thickness (mm)	0,45 - 0,50 - 0,60 - 0,70
Inner Sheet Thickness (mm)	0,35 - 0,40 - 0,45 - 0,50 - 0,60 - 0,70
Place of Production	Sakarya
Certificates	
Usage Areas	

* Uniformly distributed load values calculated according to 0,50 mm outer sheet, 0,40 mm inner sheet and 1,50 m multi span.
 ** Certificate is valid for PIR insulated panels.

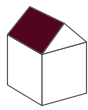

INSULATED SANDWICH ROOF PANELS

PUR/PIR Insulated 5 Ribs Membrane Roof Panel - Single Sheet RP-5SM / RI-5SM

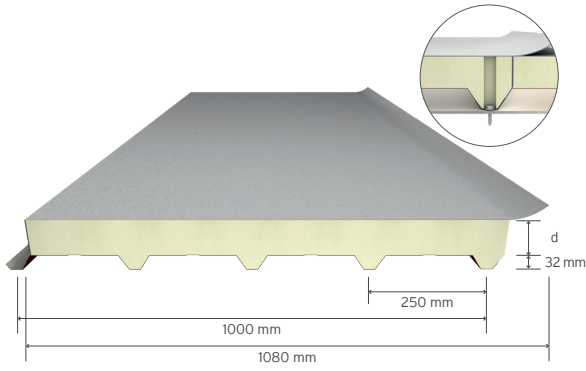

Core Material	PUR PIR
Fire Performance	- BROOF (t2)
Core Thickness = d (mm)	40 - 50 - 60 - 70 - 75 - 80 - 100 - 120 - 150 - 180 - 200
Outer Sheet Thickness (mm)	1,20 - 1,50 - 2,00 (PVC or TPO Membrane)
Inner Sheet Thickness (mm)	0,50 0,60 0,70 0,80
Distributed Load* (kg/m²)	131 161 188 214
Place of Production	Mersin, Sakarya, İzmir
Certificates	TS EN ISO 9001 TS ISO/IEC 27001 GOST-R GOST-K
Usage Areas	

* Uniformly distributed load values calculated for all core thickness according to 1,50 m multi span.
 ** Certificate is valid for PIR insulated panels.

PUR/PIR Insulated 3 Ribs GRP Roof Panel RP-3SC / RI-3SC

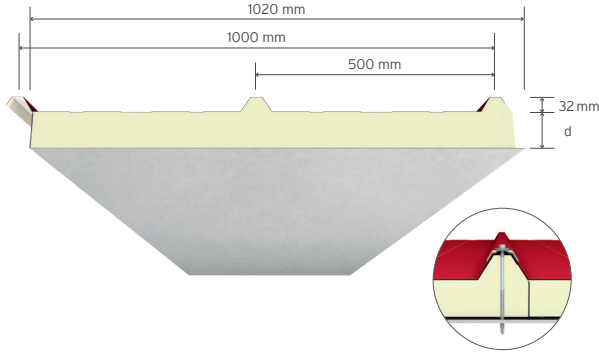

Core Material	PUR - PIR
Core Thickness = d (mm)	40 50 60 70 75 80 100 120 150 180 200
Distributed Load* (kg/m²)	98 140 189 237 252 265 317 414 529 567 638
Outer Sheet Thickness (mm)	0,45 - 0,50 - 0,60 - 0,70 - 0,80
Inner Sheet Thickness (mm)	0,70 - 1,00 CTP
Place of Production	Mersin, Sakarya, İzmir
Certificates	TS EN ISO 9001 TS ISO/IEC 27001 GOST-R GOST-K
Usage Areas	

* Uniformly distributed load values calculated according to 0,50 mm outer sheet, 0,70 mm GRP inner sheet and 1,00 m multi span.
 ** Certificate is valid for PIR insulated panels.

PUR/PIR Insulated 5 Ribs GRP Roof Panel RP-5SC / RI-5SC

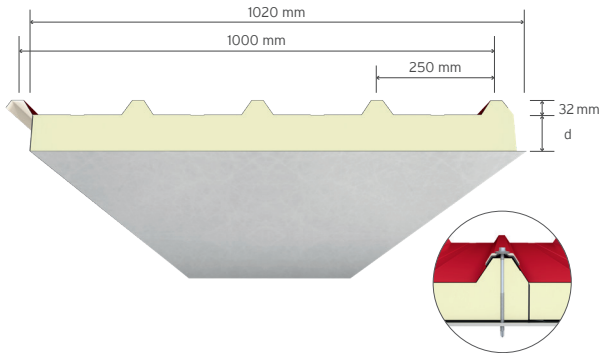

Core Material	PUR - PIR
Core Thickness = d (mm)	40 50 60 70 75 80 100 120 150 180 200
Distributed Load* (kg/m²)	100 142 192 240 263 276 343 456 544 597 713
Outer Sheet Thickness (mm)	0,45 - 0,50 - 0,60 - 0,70 - 0,80
Inner Sheet Thickness (mm)	0,70 - 1,00 CTP
Place of Production	Mersin, Sakarya, İzmir
Certificates	TS EN ISO 9001 TS ISO/IEC 27001 GOST-R GOST-K
Usage Areas	

* Uniformly distributed load values calculated according to 0,50 mm outer sheet, 0,70 mm GRP inner sheet and 1,00 m multi span.
 ** Certificate is valid for PIR insulated panels.



Rock Wool Insulated 5 Ribs Roof Panel RR-5S

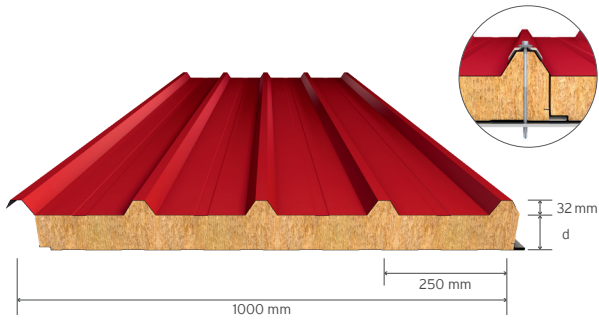

Core Material	Rock Wool
Fire Performance	A2-s1; d0
Core Thickness = d (mm)	50 60 80 100 120 150
Distributed Load* (kg/m²)	313 365 451 525 547 555
Outer Sheet Thickness (mm)	0,50 - 0,60 - 0,70 - 0,80
Inner Sheet Thickness (mm)	0,40 - 0,45 - 0,50 - 0,60 - 0,70 - 0,80
Place of Production	Mersin, Sakarya

Certificates



Usage Areas



* Uniformly distributed load values calculated according to 0,50 mm outer sheet, 0,50 mm inner sheet and 1,50 m multi span.

Rock Wool Insulated 5 Ribs Membrane Roof Panel - Single Sheet RR-5SM

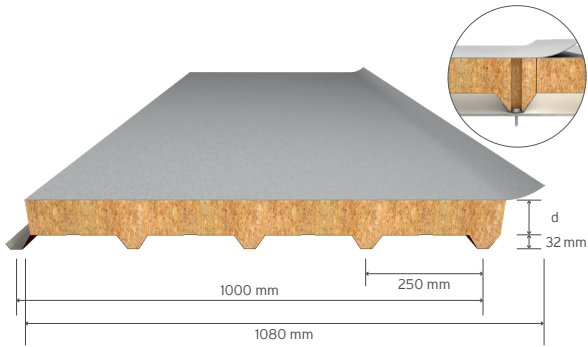

Core Material	Rock Wool
Fire Performance	BR00F (t2)
Core Thickness = d (mm)	50 - 60 - 80 - 100 - 120 - 150
Outer Sheet Thickness (mm)	1,20 - 1,50 - 2,00 (PVC or TPO Membrane)
Inner Sheet Thickness (mm)	0,50 0,60 0,70 0,80
Distributed Load* (kg/m²)	131 161 188 214
Place of Production	Mersin, Sakarya

Certificates



Usage Areas



* Uniformly distributed load values calculated for all core thickness according to 1,50 m multi span.



INSULATED SANDWICH WALL PANELS

PUR/PIR Insulated Standard Lined Wall Panel WP-SP / WI-SP

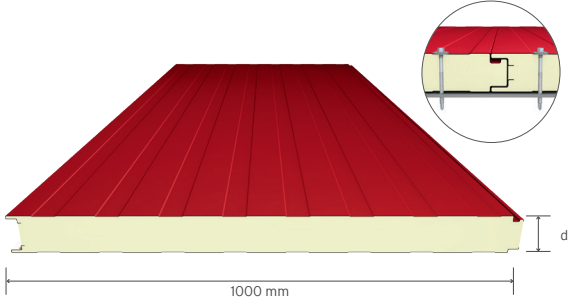

Core Material	PUR PIR
Fire Performance	B-s2; d0 B-s1; d0
Core Thickness = d (mm)	40 50 60 70 75 80 100 120 150 180 200
Distributed Load* (kg/m²)	175 222 271 320 345 370 471 574 732 892 999
Outer Sheet Thickness (mm)	0,45 - 0,50 - 0,60 - 0,70 - 0,80
Inner Sheet Thickness (mm)	0,35 - 0,40 - 0,45 - 0,50 - 0,60 - 0,70 - 0,80
Place of Production	Mersin, Sakarya, İzmir

Certificates       

Usage Areas     

* Uniformly distributed load values calculated according to 0,50 mm outer sheet, 0,40 mm inner sheet and 2,00 m multi span.
** Certificate is valid for PIR insulated panels.

PUR/PIR Insulated Standard Micro Lined Wall Panel WP-SM / WI-SM

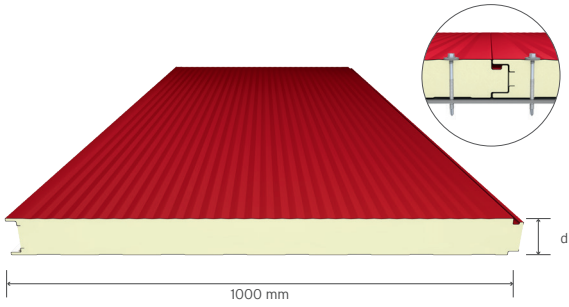

Core Material	PUR PIR
Fire Performance	B-s2; d0 B-s1; d0
Core Thickness = d (mm)	40 50 60 70 75 80 100 120 150 180 200
Distributed Load* (kg/m²)	175 222 271 320 345 370 471 574 732 892 999
Outer Sheet Thickness (mm)	0,45 - 0,50 - 0,60 - 0,70 - 0,80
Inner Sheet Thickness (mm)	0,35 - 0,40 - 0,45 - 0,50 - 0,60 - 0,70 - 0,80
Place of Production	Mersin, Sakarya, İzmir

Certificates       

Usage Areas     

* Uniformly distributed load values calculated according to 0,50 mm outer sheet, 0,40 mm inner sheet and 2,00 m multi span.
** Certificate is valid for PIR insulated panels.

PUR/PIR Insulated Standard Deep Lined Wall Panel WP-SD / WI-SD

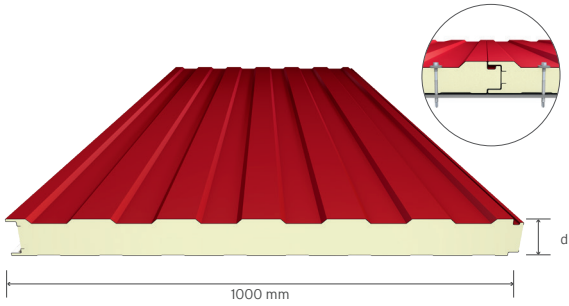

Core Material	PUR PIR
Fire Performance	B-s2; d0 B-s1; d0
Core Thickness = d (mm)	40 50 60
Distributed Load* (kg/m²)	175 222 271
Outer Sheet Thickness (mm)	0,45 - 0,50 - 0,60 - 0,70 - 0,80
Inner Sheet Thickness (mm)	0,35 - 0,40 - 0,45 - 0,50 - 0,60 - 0,70 - 0,80
Place of Production	Mersin

Certificates       

Usage Areas     

* Uniformly distributed load values calculated according to 0,50 mm outer sheet, 0,40 mm inner sheet and 2,00 m multi span.
** Certificate is valid for PIR insulated panels.

PUR/PIR Insulated Secret Fix Lined Wall Panel WP-HP / WI-HP

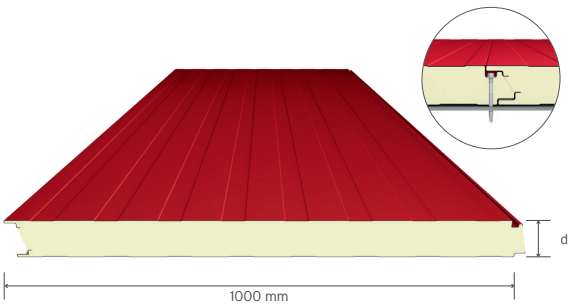

Core Material	PUR PIR
Fire Performance	B-s2; d0 B-s1; d0
Core Thickness = d (mm)	40 50 60 70 75 80 100 120 150 180 200
Distributed Load* (kg/m²)	190 242 294 348 375 402 512 624 795 969 1086
Outer Sheet Thickness (mm)	0,45 - 0,50 - 0,60 - 0,70 - 0,80
Inner Sheet Thickness (mm)	0,35 - 0,40 - 0,45 - 0,50 - 0,60 - 0,70 - 0,80
Place of Production	Mersin, Sakarya, İzmir

Certificates        

Usage Areas     

* Uniformly distributed load values calculated according to 0,50 mm outer sheet, 0,40 mm inner sheet and 2,00 m multi span.
** Certificate is valid for PIR insulated panels.



PUR/PIR Insulated Secret Fix Micro Lined Wall Panel WP-HM / WI-HM

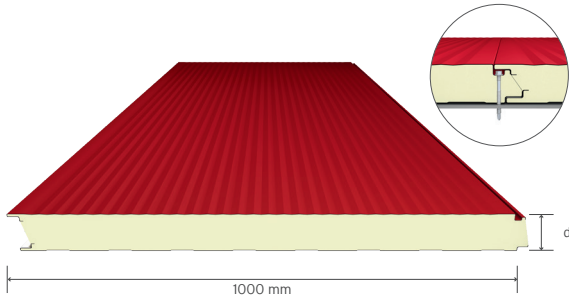

Core Material	PUR PIR
Fire Performance	B-s2; d0 B-s1; d0
Core Thickness = d (mm)	40 50 60 70 75 80 100 120 150 180 200
Distributed Load* (kg/m²)	190 242 294 348 375 402 512 624 795 969 1086
Outer Sheet Thickness (mm)	0,45 - 0,50 - 0,60 - 0,70 - 0,80
Inner Sheet Thickness (mm)	0,35 - 0,40 - 0,45 - 0,50 - 0,60 - 0,70 - 0,80
Place of Production	Mersin, Sakarya, İzmir

Certificates



Usage Areas



* Uniformly distributed load values calculated according to 0,50 mm outer sheet, 0,40 mm inner sheet and 2,00 m multi span.
** Certificate is valid for PIR insulated panels.

PUR/PIR Insulated Secret Fix Deep Lined Wall Panel WP-HD / WI-HD

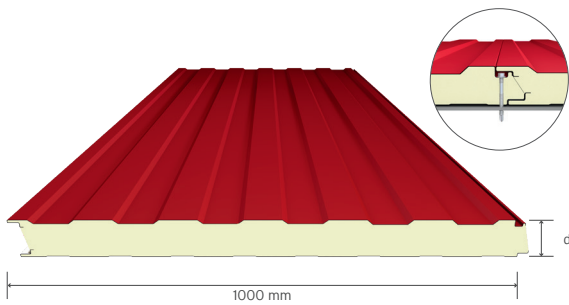

Core Material	PUR PIR
Fire Performance	B-s2; d0 B-s1; d0
Core Thickness = d (mm)	40 50 60
Distributed Load* (kg/m²)	190 242 294
Outer Sheet Thickness (mm)	0,45 - 0,50 - 0,60 - 0,70 - 0,80
Inner Sheet Thickness (mm)	0,35 - 0,40 - 0,45 - 0,50 - 0,60 - 0,70 - 0,80
Place of Production	Mersin

Certificates



Usage Areas



* Uniformly distributed load values calculated according to 0,50 mm outer sheet, 0,40 mm inner sheet and 2,00 m multi span.
** Certificate is valid for PIR insulated panels.

PUR/PIR Insulated Secret Fix Sinus & Lined Wall Panel WP-HPS / WI-HPS

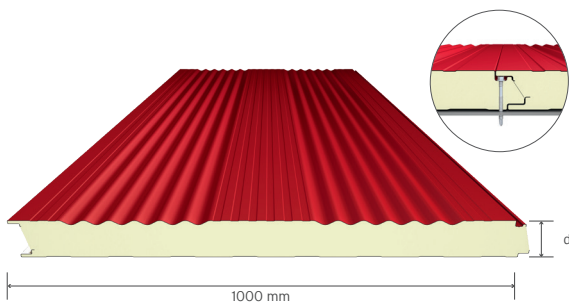

Core Material	PUR PIR
Fire Performance	B-s2; d0 B-s1; d0
Core Thickness = d (mm)	40 50 60 70 75 80 100 120 150 180 200
Distributed Load* (kg/m²)	190 242 294 348 375 402 512 624 795 969 1086
Outer Sheet Thickness (mm)	0,45 - 0,50 - 0,60 - 0,70
Inner Sheet Thickness (mm)	0,35 - 0,40 - 0,45 - 0,50 - 0,60 - 0,70
Place of Production	Sakarya

Certificates



Usage Areas



* Uniformly distributed load values calculated according to 0,50 mm outer sheet, 0,40 mm inner sheet and 2,00 m multi span.

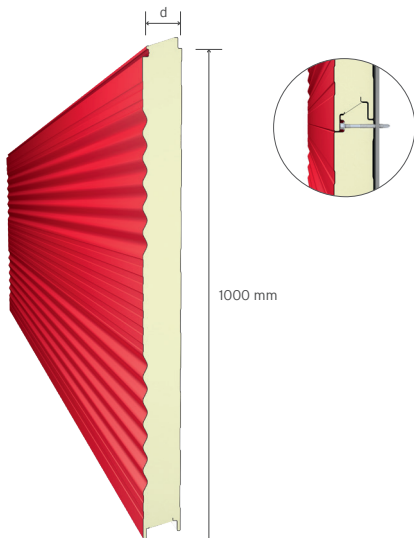



INSULATED SANDWICH WALL PANELS

Rock Wool Insulated Standard Lined Wall Panel WR-SP

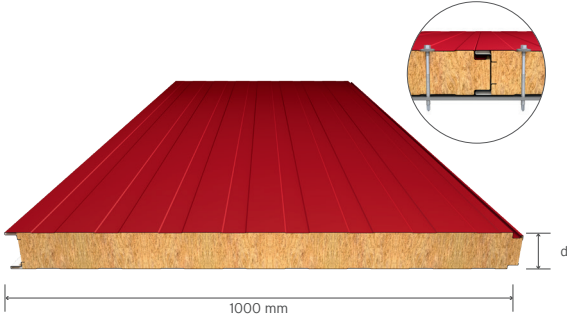

Core Material	Rock Wool
Fire Performance	A2-s1; d0
Core Thickness = d (mm)	50 60 80 100 120 150
Distributed Load* (kg/m²)	156 190 260 333 407 520
Outer Sheet Thickness (mm)	0,50 - 0,60 - 0,70 - 0,80
Inner Sheet Thickness (mm)	0,40 - 0,45 - 0,50 - 0,60 - 0,70 - 0,80
Place of Production	Mersin, Sakarya

Certificates TSE CE TS EN ISO 9001 TS ISO/IEC 27001 GOST-R GOST-K

Usage Areas

* Uniformly distributed load values calculated according to 0,50 mm outer sheet, 0,50 mm inner sheet and 2,00 m multi span.

Rock Wool Insulated Standard Micro Lined Wall Panel WR-SM

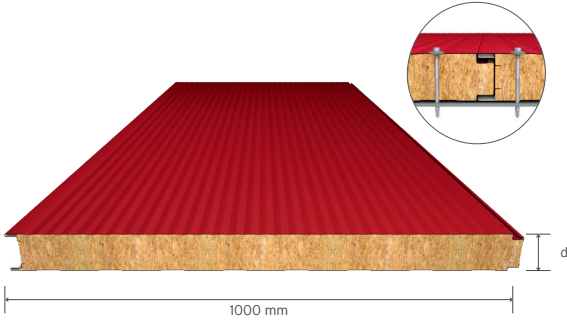

Core Material	Rock Wool
Fire Performance	A2-s1; d0
Core Thickness = d (mm)	50 60 80 100 120 150
Distributed Load* (kg/m²)	156 190 260 333 407 520
Outer Sheet Thickness (mm)	0,50 - 0,60 - 0,70 - 0,80
Inner Sheet Thickness (mm)	0,40 - 0,45 - 0,50 - 0,60 - 0,70 - 0,80
Place of Production	Mersin, Sakarya

Certificates TSE CE TS EN ISO 9001 TS ISO/IEC 27001 GOST-R GOST-K

Usage Areas

* Uniformly distributed load values calculated according to 0,50 mm outer sheet, 0,50 mm inner sheet and 2,00 m multi span.

Rock Wool Insulated Secret Fix Lined Wall Panel - Mersin WR-YP

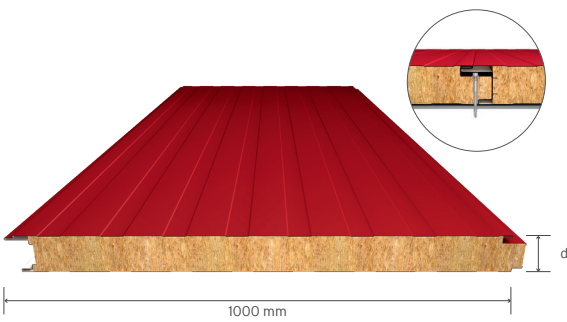

Core Material	Rock Wool
Fire Performance	A2-s1; d0
Core Thickness = d (mm)	50 60 80 100 120 150
Distributed Load* (kg/m²)	169 206 283 361 442 565
Outer Sheet Thickness (mm)	0,50 - 0,60 - 0,70 - 0,80
Inner Sheet Thickness (mm)	0,40 - 0,45 - 0,50 - 0,60 - 0,70 - 0,80
Place of Production	Mersin

Certificates TSE CE TS EN ISO 9001 TS ISO/IEC 27001 GOST-R GOST-K

Usage Areas

* Uniformly distributed load values calculated according to 0,50 mm outer sheet, 0,50 mm inner sheet and 2,00 m multi span.



Rock Wool Insulated Secret Fix Micro Lined Wall Panel - Mersin WR-YM

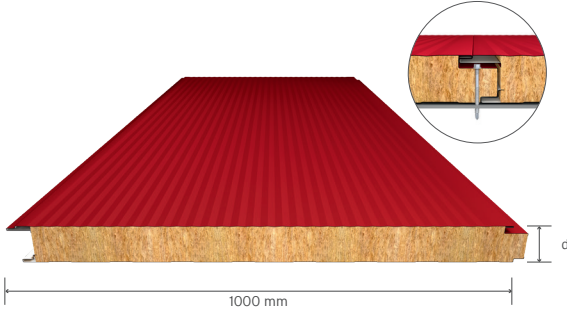

Core Material	Rock Wool
Fire Performance	A2-s1; d0
Core Thickness = d (mm)	50 60 80 100 120 150
Distributed Load* (kg/m²)	169 206 361 442 565
Outer Sheet Thickness (mm)	0,50 - 0,60 - 0,70 - 0,80
Inner Sheet Thickness (mm)	0,40 - 0,45 - 0,50 - 0,60 - 0,70 - 0,80
Place of Production	Mersin

Certificates      

Usage Areas    

* Uniformly distributed load values calculated according to 0,50 mm outer sheet, 0,50 mm inner sheet and 2,00 m multi span.

Rock Wool Insulated Secret Fix Lined Wall Panel - Sakarya WR-HP

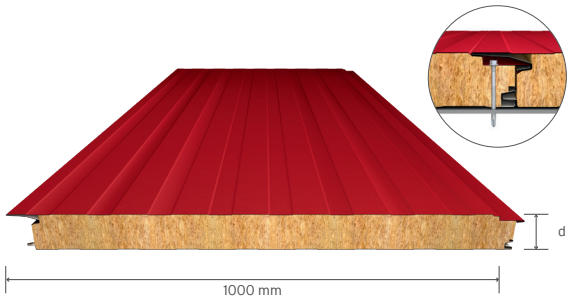

Core Material	Rock Wool
Fire Performance	A2-s1; d0
Core Thickness = d (mm)	50 60 80 100 120 150
Distributed Load* (kg/m²)	169 206 283 361 442 565
Outer Sheet Thickness (mm)	0,50 - 0,60 - 0,70 - 0,80
Inner Sheet Thickness (mm)	0,40 - 0,45 - 0,50 - 0,60 - 0,70 - 0,80
Place of Production	Sakarya

Certificates      

Usage Areas    

* Uniformly distributed load values calculated according to 0,50 mm outer sheet, 0,50 mm inner sheet and 2,00 m multi span.

Rock Wool Insulated Secret Fix Micro Lined Wall Panel - Sakarya WR-HM

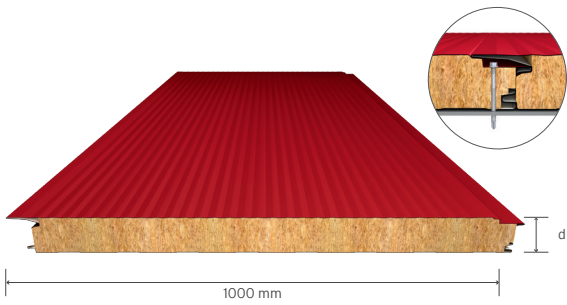

Core Material	Rock Wool
Fire Performance	A2-s1; d0
Core Thickness = d (mm)	50 60 80 100 120 150
Distributed Load* (kg/m²)	169 206 283 361 442 565
Outer Sheet Thickness (mm)	0,50 - 0,60 - 0,70 - 0,80
Inner Sheet Thickness (mm)	0,40 - 0,45 - 0,50 - 0,60 - 0,70 - 0,80
Place of Production	Sakarya

Certificates      

Usage Areas    







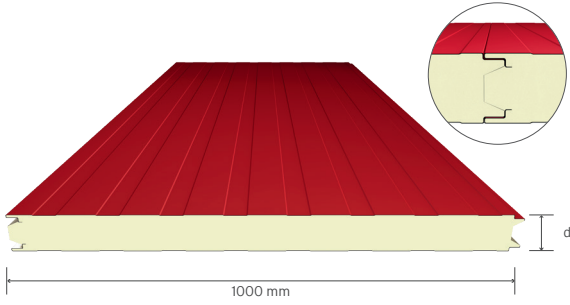

* Uniformly distributed load values calculated according to 0,50 mm outer sheet, 0,50 mm inner sheet and 2,00 m multi span.



INSULATED COLD STORAGE SANDWICH PANELS

PUR/PIR Insulated Cold Storage Panel CP-SP / CI-SP









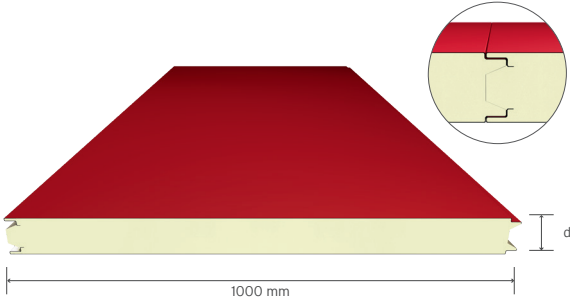

Core Material	PUR PIR
Fire Performance	B-s2; d0 B-s1; d0
Core Thickness = d (mm)	80 - 100 - 120 - 150 - 180 - 200
Outer Sheet Thickness (mm)	0,50 - 0,60 - 0,70 - 0,80
Inner Sheet Thickness (mm)	0,40 - 0,45 - 0,50 - 0,60 - 0,70 - 0,80
Place of Production	Mersin, İzmir
Certificates	       
Usage Areas	

* Certificate is valid for PIR insulated panels.

PUR/PIR Insulated Flat Cold Storage Panel CP-SP Flat / CI-SP Flat







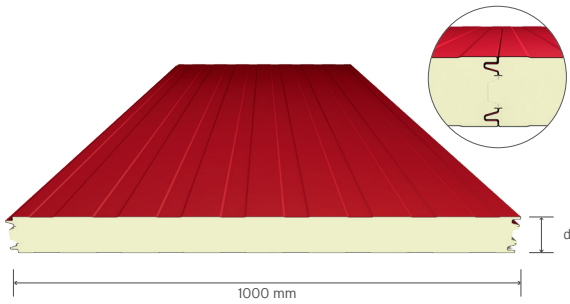

Core Material	PUR PIR
Fire Performance	B-s2; d0 B-s1; d0
Core Thickness = d (mm)	80 - 100 - 120 - 150 - 180 - 200
Outer Sheet Thickness (mm)	0,50 - 0,60 - 0,70 - 0,80
Inner Sheet Thickness (mm)	0,50 - 0,60 - 0,70 - 0,80
Place of Production	Mersin, İzmir
Certificates	       
Usage Areas	

* Certificate is valid for PIR insulated panels.

PUR/PIR Insulated Cold Storage Panel - Sakarya CP-SS / CI-SS







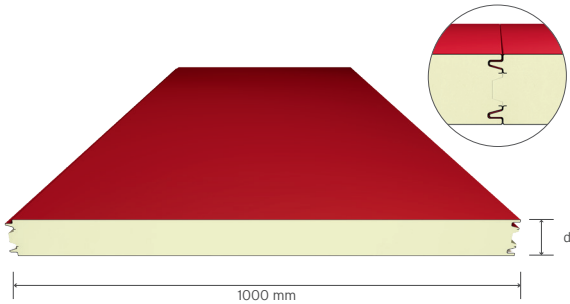

Core Material	PUR PIR
Fire Performance	B-s2; d0 B-s1; d0
Core Thickness = d (mm)	80 - 100 - 120 - 150 - 180 - 200
Outer Sheet Thickness (mm)	0,50 - 0,60 - 0,70 - 0,80
Inner Sheet Thickness (mm)	0,40 - 0,45 - 0,50 - 0,60 - 0,70 - 0,80
Place of Production	Sakarya
Certificates	     
Usage Areas	

* Certificate is valid for PIR insulated panels.

PUR/PIR Insulated Flat Cold Storage Panel - Sakarya CP-SS Flat / CI-SS Flat



Core Material	PUR PIR
Fire Performance	B-s2; d0 B-s1; d0
Core Thickness = d (mm)	80 - 100 - 120 - 150 - 180 - 200
Outer Sheet Thickness (mm)	0,50 - 0,60 - 0,70 - 0,80
Inner Sheet Thickness (mm)	0,50 - 0,60 - 0,70 - 0,80
Place of Production	Sakarya
Certificates	     
Usage Areas	

* Certificate is valid for PIR insulated panels.



Rock Wool Insulated 5 Ribs Acoustic Roof Panel RR-5SK

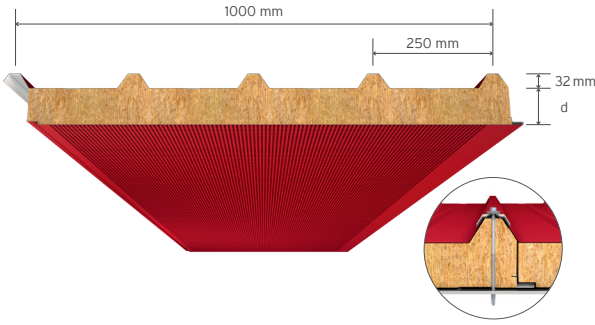

Core Material	Rock Wool
Core Thickness = d (mm)	50 60 80 100 120 150
Sound Reduction Value - Rw dB (500Hz)	~34
Sound Absorption Coefficient - a_w (500Hz)	~0,85
Outer Sheet Thickness (mm)	0,50 - 0,60 - 0,70 - 0,80
Inner Sheet Thickness (mm)	0,50 - 0,60 - 0,70 - 0,80
Place of Production	Mersin, Sakarya
Certificates	TS EN ISO 9001 TS ISO/IEC 27001 GOST-K
Usage Areas	

Rock Wool Insulated Acoustic Standard Wall Panel WR-SK

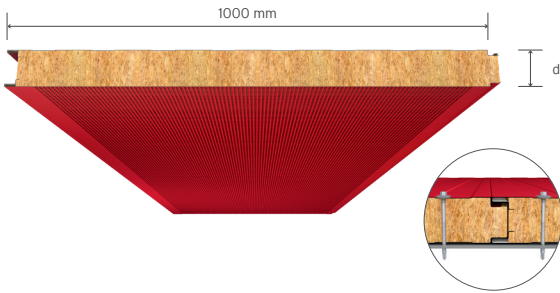

Core Material	Rock Wool
Core Thickness = d (mm)	50 60 80 100 120 150
Sound Reduction Value - Rw dB (500Hz)	~34
Sound Absorption Coefficient - a_w (500Hz)	~0,85
Outer Sheet Thickness (mm)	0,50 - 0,60 - 0,70 - 0,80
Inner Sheet Thickness (mm)	0,50 - 0,60 - 0,70 - 0,80
Place of Production	Mersin, Sakarya
Certificates	TS EN ISO 9001 TS ISO/IEC 27001 GOST-K
Usage Areas	

Rock Wool Insulated Acoustic Secret Fix Wall Panel - Mersin WR-YK

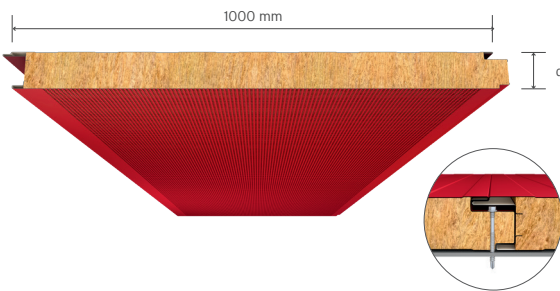

Core Material	Rock Wool
Core Thickness = d (mm)	50 60 80 100 120 150
Sound Reduction Value - Rw dB (500Hz)	~34
Sound Absorption Coefficient - a_w (500Hz)	~0,85
Outer Sheet Thickness (mm)	0,50 - 0,60 - 0,70 - 0,80
Inner Sheet Thickness (mm)	0,50 - 0,60 - 0,70 - 0,80
Place of Production	Mersin
Certificates	TS EN ISO 9001 TS ISO/IEC 27001 GOST-K
Usage Areas	

Rock Wool Insulated Acoustic Secret Fix Wall Panel - Sakarya WR-HK

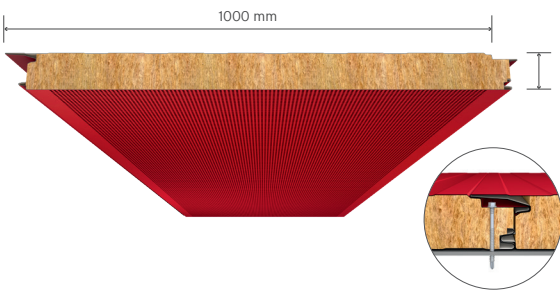

Core Material	Rock Wool
Core Thickness = d (mm)	50 60 80 100 120 150
Sound Reduction Value - Rw dB (500Hz)	~34
Sound Absorption Coefficient - a_w (500Hz)	~0,85
Outer Sheet Thickness (mm)	0,50 - 0,60 - 0,70 - 0,80
Inner Sheet Thickness (mm)	0,50 - 0,60 - 0,70 - 0,80
Place of Production	Sakarya
Certificates	TS EN ISO 9001 TS ISO/IEC 27001 GOST-K
Usage Areas	



TEKNOBOARD THERMAL INSULATION BOARD

PUR/PIR Insulated Thermal Insulation Board BP-PP / BI-PP

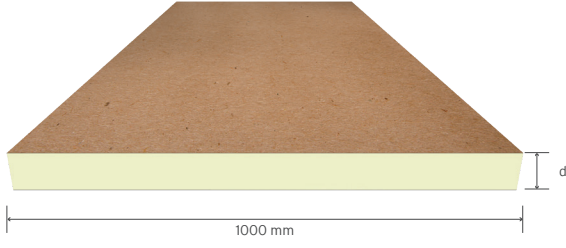

Core Material	PUR PIR
Density (kg/m³)	38 (±2) 40 (±2)
Thermal Conductivity Coefficient (W/mK)	0,022 0,023
Core Thickness = d (mm)	20* - 30 - 40 - 50 - 60 - 80 - 100
Lower and Upper Surface	Natural Kraft Paper, Aluminum Foil, PVC Membrane
Place of Production	Sakarya
Certificates	TS EN ISO 9001 TS ISO/IEC 27001
Usage Areas	

* Please contact Teknpanel for density values.



ISOTRAPEZ SINGLE SHEET PANEL

PUR Insulated 9 Ribs Single Sheet Panel RP-9T

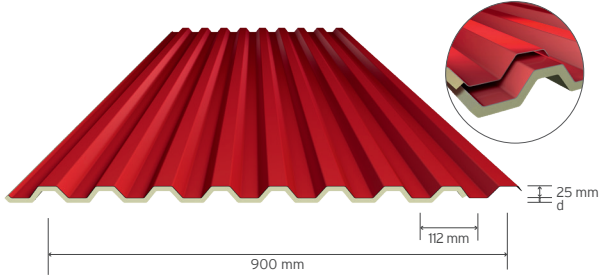

Core Material	PUR
Core Thickness = d (mm)	15
Outer Sheet Metal Type	Prepainted Galvanized Steel
Outer Sheet Thickness (mm)	0,35 - 0,40 - 0,50 - 0,60 - 0,70
Inner Sheet	Polyethylene Film, Aluminum Foil
Place of Production	İzmir
Certificates	TS EN ISO 9001 TS ISO/IEC 27001
Usage Areas	



TRAPEZOIDAL SHEETS

3 Ribs Roof Panel Profiled Trapezoidal Sheet TKT-03

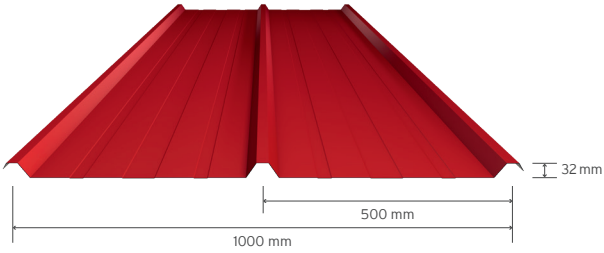

Metal Type	Prepainted Galvanized Steel
Metal Thickness (mm)	0,40 - 0,50 - 0,60 - 0,70 - 0,80
Place of Production	Mersin, Sakarya, İzmir
Certificates	TS EN ISO 9001 TS ISO/IEC 27001
Usage Areas	

• Technical specifications are for TKT-03 and TKT-05 products.

5 Ribs Roof Panel Profiled Trapezoidal Sheet TKT-05

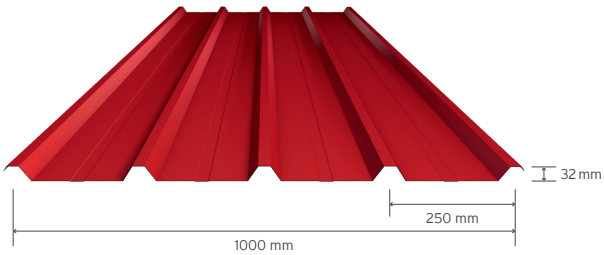



Teknopanel Çatı ve Cephe Panelleri Üretim San. ve Tic. A.Ş.

📍 Head Office - Mersin Factory

📍 Sakarya Factory

📍 İzmir Factory

📍 İstanbul Factory

📍 İstanbul Office

 /TeknopanelAS

 /TeknopanelAS

 /teknopanelas

 /teknopanelas

+90 850 777 0850
teknopanel.com.tr